

TGM1N Series Moulded Case Circuit Breaker



1 Product overview

TGM1N series moulded case circuit breaker is a new type of circuit breaker developed with international advanced technology platform. It is suitable for power distribution protection in AC 50/60Hz, circuits with the rated working voltage $\leq 690V$, and can also be used for occasional circuit switch and startup of motor. This product has the advantages of exquisite appearance, compact volume, convenient maintenance, excellent performance, etc.. It can fully replace the M1 series products in the market due to its excellent performance and high cost performance.

This series circuit breaker is equipped with overload and short circuit protection devices. This series circuit breaker may be installed vertically (i.e., vertical installation) or horizontally (i.e., horizontal installation).

It has disconnecting function, with the corresponding symbol of: 
The circuit breaker shall meet the standard IEC 60947-1 and IEC 60947-2
Certificate: CE.

2 Type designation

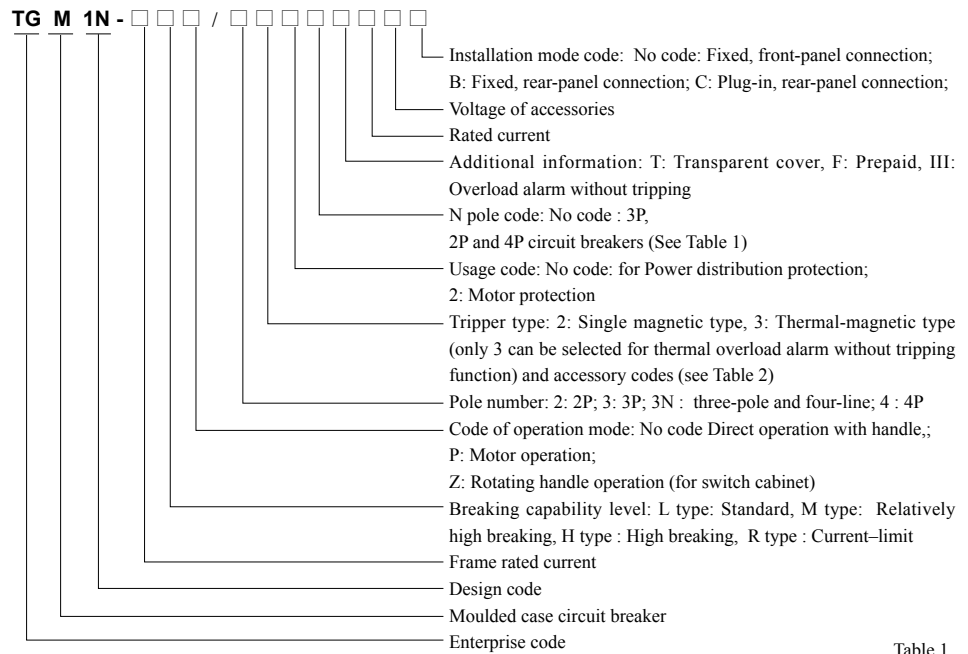

Table 1

Wiring mode		
Type A	N pole is not equipped with over-current tripping element, has been connected with all along, and does not act with other three poles	3N300A
B	N pole is not equipped with over-current tripping element, and acts with other three poles (N-pole turn on prior to turn off)	4300B
Type C	N pole is equipped with over-current tripping element, and acts with other three poles (N-pole turn on prior to turn off)	4300C
Type D	N pole is equipped with over-current tripping element, has been connected with all along, and does not act with other three poles	3N300D

Note: No code for 3-pole products. Type A and Type D are corresponding to 1N and 3N, respectively. 2-pole product and 4-pole product are corresponding to Type B and Type C.

Currently, there is no transparent cover product for 63/125/630 large volume/ 800/1250 frame.

Currently, there is no transparent cover 2P product.

2.1 View of codes of 4-pole product



Type A: N pole is not equipped with over-current tripping element, has been connected with all along, and does not act with other three poles.

Without over-current tripper



Type B: N pole is not equipped with over-current tripping element, and acts with other three poles (N-pole turn on prior to turn off).

Without over-current tripper

TGM1N Series Moulded Case Circuit Breaker



Type C: N pole is equipped with over-current tripping element, and acts with other three poles (N-pole turn on prior to turn off).

With over-current tripper



Type D: N pole is equipped with over-current tripping element, has been connected with all along, and does not act with other three poles.

With over-current tripper

2.2 Table of codes for internal accessories

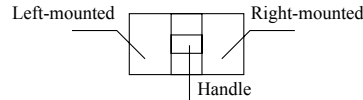

Alarm contact ● Auxiliary contact ○
Shunt release ■ Undervoltage release ▲

Table 2

Accessory Name	Accessory code	TGM1N-63 TGM1N-125	TGM1N-160	TGM1N-250 TGM1N-320	TGM1N-400 TGM1N-630 TGM1N-800	TGM1N-1250
		Standard setting	Standard setting	Standard setting	Standard setting	Standard setting
No accessories	00					
Alarm contact	08					
Shunt release	10					
Auxiliary contact	20					
Undervoltage release	30					
Shunt release Auxiliary contact	40					
Shunt release Undervoltage release	50					
Two sets Auxiliary contact	60					
Auxiliary contact Undervoltage release	70					
Shunt release Alarm contact	18					
Auxiliary contact Alarm contact	28					
Undervoltage release Alarm contact	38					
Shunt release Auxiliary contact Alarm contact	48					
Two groups of auxiliary contacts Alarm contact	68					
Undervoltage release Auxiliary contact Alarm contact	78					

★ Note: Internal accessories shall be installed on left and right. Please specify the installation direction (such as right shunt) of the accessories when ordering. Otherwise, the standard setting shall be adopted. Prepaid shunt is suitable to 160-800 frames.

Transparent cover circuit breakers shall not be equipped with accessories.

A set of auxiliary contacts include 1NO+1NC contact for below 400 type; a set of auxiliary contacts include 2NO+2NC contacts for 400 and above 400 types.

2.3 Applicable frame current of overload alarm without tripping

Frame current	160	250/320	400	630	800
Rated current	16、20、25、32、40、50、60、63、70、75、80、100、125	100、125、140、150、160、170、180、200、225、250	250、280、300、315、320、350、380、400	400、450、500、550、600、630	630、700、800

Remarks: 3P, 3P+N A type and 4P B type can be equipped with overload alarm without tripping accessories (only applicable to L and M types)

TGM1N Series Moulded Case Circuit Breaker

2.4 Feature of overload alarm without tripping

Overload alarm without tripping refers to that the circuit breaker B11-B14 is connected to send alarm signal, but the circuit breaker does not trip when the actual current exceeds the overload tripping current and the circuit breaker reaches the tripping time.

- Working schematic diagram

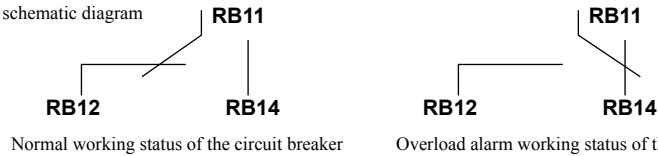

3 Product parameter

3.1 Basic parameters

Table 3

Basic parameters																					
Frame current	63				125				160				250				320				
Rated working voltage Ue(V)	AC230/240、AC380/400/415、AC660/690				AC230/240、AC380/400/415、AC660/690				AC230/240、AC380/400/415、AC660/690				AC230/240、AC380/400/415、AC660/690				AC230/240、AC380/400/415、AC660/690				
Rated insulation voltage Ui(V)	800				800				1000				1000				1000				
Rated impulse withstand voltage Uimp(kV)	8				8				8				12				12				
Rated frequency Hz	AC (50/60Hz)																				
Rated current In(A)	10, 16, 20, 25, 32, 40, 50, 63				10, 16, 20, 25, 32, 40, 50, 63, 80, 100, 125				16, 20, 25, 32, 40, 50, 60, 63, 70, 75, 80, 100, 125, 140, 150, 160				100, 125, 140, 150, 160, 170, 180, 200, 225, 250				100, 125, 140, 150, 160, 170, 180, 200, 225, 250, 270, 280, 300, 315, 320				
Short-circuit protection setting value Ii	6In, 8In, 10In, 12In																				
Breaking capability	L	M	H	R	L	M	H	R	L	M	H	R	L	M	H	R	L	M	H	R	
Icu	2P: (AC230/240V) (kA)	35	50	/	/	35	50	/	/	50	70	/	/	50	70	/	/	50	70	/	/
	3P4P: (AC380/400/415V) (kA)	25	35	50	70	25	35	50	70	35	50	70	85	35	50	70	85	35	50	70	85
	3P4P: (AC660/690V) (kA)	5	5	8	10	5	5	8	10	10	10	10	20	10	10	10	20	10	10	10	20
Ics	2P: (AC230/240V) (kA)	25	35	/	/	25	35	/	/	35	50	/	/	35	50	/	/	35	50	/	/
	3P4P: (AC380/400/415V) (kA)	18	25	35	50	18	25	35	50	25	35	50	65	25	35	50	65	25	35	50	65
	3P4P: (AC660/690V) (kA)	5	5	8	10	5	5	8	10	8	8	10	10	8	8	10	10	8	8	10	10
Applicable working ambient temperature	-5°C ~ +30°C																				
Use category	A																				
Flashover distance (mm)	≤50				≤50				≤50				≤50				≤50				
Isolating function	With (without for 1P+N, 3P+N)																				
Mechanical life (times)	Maintenance-free	20000				20000				20000				20000				20000			
	Maintenance needed	40000				40000				40000				40000				40000			
Electrical life (times)	10000				10000				10000				10000				10000				
Protection type	Power distribution protection	Power distribution protection				Power distribution protection				Power distribution protection				Power distribution protection							
	Motor protection	Motor protection				Motor protection				Motor protection				Motor protection							
Tripping mode	Thermal magnetic	Thermal magnetic				Thermal magnetic				Thermal magnetic				Thermal magnetic							
	Single-magnetic	Single-magnetic				Single-magnetic				Single-magnetic				Single-magnetic							
Overload alarm without tripping	2P, 4P/C type 4P/D type	-				-				-				-							
	3P, 4P/A type 4P/B type	-				-				■				■							
Prepayment function	-				-				■				■								

TGM1N Series Moulded Case Circuit Breaker

Continued table 3

Basic parameters																	
Frame current	400			630			630 large volume			800			1250		1250 small volume		
Rated working voltage U_e (V)	AC380/400/415, AC660/690			AC380/400/415, AC660/690			AC400/415 AC660/690			AC380/400/415 AC660/690			AC400		AC400		
Rated insulation voltage U_i (V)	1000			1000			800			1000			800		800		
Rated impulse withstand voltage U_{imp} (kV)	12			12			8			12			12		12		
Rated frequency Hz	AC (50/60Hz)						AC (50Hz)			AC (50/60Hz)			AC (50Hz)		AC (50Hz)		
Rated current I_n (A)	250, 280, 300, 315, 320, 350, 380, 400			400, 450, 500, 550, 600, 630			400, 500, 630			630, 700, 800			630, 700, 800, 1000, 1250				
Short-circuit protection setting value I_i	6In, 8In, 10In, 12In											≤800A; 10In ≥1000A; 7In					
Breaking capability	L	M	H	L	M	H	L	M	L	M	H	L	M	H			
I_{cu}	2P; (AC230/240V) (kA)	/	/	/	/	/	/	/	/	/	/	/	/	/			
	3P/4P; (AC380/400/415V) (kA)	50	70	100	50	70	100	50	65	50	70	100	80	65	80		
	3P/4P; (AC660/690V) (kA)	10	15	20	10	15	20	10	10	15	20	20	/	/	/		
I_{cs}	2P; (AC230/240V) (kA)	/	/	/	/	/	/	/	/	/	/	/	/	/			
	3P/4P; (AC380/400/415V) (kA)	35	50	75	35	50	75	35	42	35	50	75	40	50	65		
	3P/4P; (AC660/690V) (kA)	10	10	10	10	10	10	5	5	15	15	15	/	/	/		
Applicable working ambient temperature	-5°C ~ +30°C																
Use Category	A																
Flashover distance (mm)	≤100			≤100			≤100			≤100			≤120		≤100		
Isolating function	With (without for 1P+N, 3P+N)																
Mechanical life (times)	Maintenance-free	10000			10000			10000			8000			5000		5000	
	Maintenance needed	20000			20000			20000			10000			5000		5000	
Electrical life (times)	8000			8000			8000			5000			5000		5000		
Protection type	Power distribution protection	Power distribution protection			Power distribution protection			Power distribution protection			Power distribution protection			5000		5000	
	Motor protection	Motor protection			Motor protection			Motor protection			Motor protection			/		/	
Tripping mode	Thermal magnetic	Thermal magnetic			Thermal magnetic			Thermal magnetic			Thermal magnetic			Thermal magnetic		Thermal magnetic	
	Single-magnetic	Single-magnetic			Single-magnetic			Single-magnetic			Single-magnetic			Single-magnetic		Single-magnetic	
Overload alarm without tripping	2P, 4P/C type 4P/D type	-			-			-			-			-		-	
	3P, 4P/A type 4P/B type	■			■			-			■			-		-	
Prepayment function	■			■			■			■			-		-		

Note: The minimum current of TGM1N-63/125H/R is 16A

3.2 Wiring mode

Table 4

Wiring mode										
Frame current	63	125	160	250	320	400	630	630 large volume	800	1250
Fixed, front-panel connection	■	■	■	■	■	■	■	■	■	■
Fixed, rear-panel connection	□	□	□	□	□	□	□	□	□	-
Plug-in rear-panel connection	□	□	□	□	□	□	□	□	□	-
Plug-in front-panel connection	□	□	□	□	□	□	□	□	□	-

TGM1N Series Moulded Case Circuit Breaker

3.3 Accessories optional

Table 5

Accessories information										
Frame current	63	125	160	250	320	400	630	630 Large volume	800	1250
Undervoltage release	<input type="checkbox"/>	<input type="checkbox"/>	<input type="checkbox"/>	<input type="checkbox"/>	<input type="checkbox"/>	<input type="checkbox"/>	<input type="checkbox"/>	<input type="checkbox"/>	<input type="checkbox"/>	-
Shunt release	<input type="checkbox"/>	<input type="checkbox"/>	<input type="checkbox"/>	<input type="checkbox"/>	<input type="checkbox"/>	<input type="checkbox"/>	<input type="checkbox"/>	<input type="checkbox"/>	<input type="checkbox"/>	<input type="checkbox"/>
Alarm contact	<input type="checkbox"/>	<input type="checkbox"/>	<input type="checkbox"/>	<input type="checkbox"/>	<input type="checkbox"/>	<input type="checkbox"/>	<input type="checkbox"/>	<input type="checkbox"/>	<input type="checkbox"/>	-
Auxiliary contact	<input type="checkbox"/>	<input type="checkbox"/>	<input type="checkbox"/>	<input type="checkbox"/>	<input type="checkbox"/>	<input type="checkbox"/>	<input type="checkbox"/>	<input type="checkbox"/>	<input type="checkbox"/>	<input type="checkbox"/>
Mechanical interlock	<input type="checkbox"/>	<input type="checkbox"/>	<input type="checkbox"/>	<input type="checkbox"/>	<input type="checkbox"/>	<input type="checkbox"/>	<input type="checkbox"/>	-	<input type="checkbox"/>	-
Terminals of transition bar	<input type="checkbox"/>	<input type="checkbox"/>	<input type="checkbox"/>	<input type="checkbox"/>	<input type="checkbox"/>	<input type="checkbox"/>	<input type="checkbox"/>	<input type="checkbox"/>	<input type="checkbox"/>	-
Electric motor operating mechanism	<input type="checkbox"/>	<input type="checkbox"/>	<input type="checkbox"/>	<input type="checkbox"/>	<input type="checkbox"/>	<input type="checkbox"/>	<input type="checkbox"/>	<input type="checkbox"/>	<input type="checkbox"/>	<input type="checkbox"/>
Circular extended rotating handle	<input type="checkbox"/>	<input type="checkbox"/>	<input type="checkbox"/>	<input type="checkbox"/>	<input type="checkbox"/>	<input type="checkbox"/>	<input type="checkbox"/>	<input type="checkbox"/>	<input type="checkbox"/>	-
Phase partition	<input checked="" type="checkbox"/>	<input checked="" type="checkbox"/>	<input checked="" type="checkbox"/>	<input checked="" type="checkbox"/>	<input checked="" type="checkbox"/>	<input checked="" type="checkbox"/>	<input checked="" type="checkbox"/>	<input checked="" type="checkbox"/>	<input checked="" type="checkbox"/>	<input checked="" type="checkbox"/>
Special for prepayment ammeter	<input type="checkbox"/>	<input type="checkbox"/>	<input type="checkbox"/>	<input type="checkbox"/>	<input type="checkbox"/>	<input type="checkbox"/>	<input type="checkbox"/>	<input type="checkbox"/>	<input type="checkbox"/>	-

 represents optional represents

 represents standard represents

3.4 Tripping characteristics of the product

Table 6

Tripper Rated Current (A)	Thermal tripper (reference temperature +30℃)		Action current for the electromagnetic tripper (A)	Remarks
	1.05In (Cold state) No-action time (h)	1.3In (thermal state) Action time (h)		
10≤In≤63	≥1	< 1	6In±20%、 8In±20%、 10In±20%	Power distribution type
63≤In≤800	≥2	< 2		
10≤In≤800	1.0In (cold state) no- action time (h)	1.2In (thermal state) action time (h)	12In±20%	Motor protection type
	≥2	< 2		

* Note: Thermal state refers to the state after the conventional non-tripping current reaches the specified time;

The features of instantaneous action below 40A shall be set according that at 40A.

3.5 Time/current characteristic curve of TGM1N

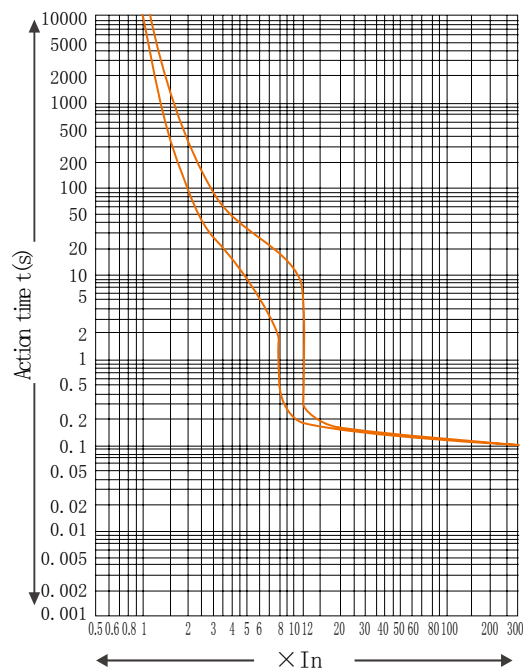

TGM1N Series Moulded Case Circuit Breaker

3.6 Breaker Power Loss Reference Table

Table 7

Model	Current	Single-pole resistance (mΩ)	Total power loss (W) of 3/4 poles		
			Front panel connection	Rear-panel connection	Plug-in rear-panel connection
(mΩ)	63	0.75	24	27	28
TGM1N-125	125	0.72	28	31	32
TGM1N-160	160	0.4	60	87	89
TGM1N-250	250	0.2	63	90	90
TGM1N-320	320	0.19	65	95	98
TGM1N-400	400	0.15	68	72	100
TGM1N-630	630	0.14	180	190	200
TGM1N-800	800	0.11	200	230	290
TGM1N-1250	1250	0.04	260	300	320

3.7 Cross-section area of the copper lead connected to the product

Table 8

Rated current (A)	10	16 20	25	32	40 50	63	80	100	125	160	180 225	250	315 350	400
Cross-sectional area of DA lead (mm ²)	1.5	2.5	4	6	10	16	25	35	50	70	95	120	185	240

Rated current (A)	Cable		Copper bar	
	Quantity	Cross-section area (mm ²)	Quantity	Cross-section area (mm ²)
500	2	150	2	30x5
630	2	185	2	40x5
800	2	240	2	50x5
1250	—	—	2	40x10
1250 Small volume	—	—	2	45x16

3.8 Screw tightening torque of the product

Table 9

Model	TGM1N-63/125	TGM1N-160	TGM1N-250/320	TGM1N-400/630	TGM1N-630 大体积 /800	TGM1N-1250
Nominal diameter of thread (mm)	M8	M8	M8	M10	M12	M12
Tightening torque (N.m)	8	10	12	22	28	30
Failure moment (N.m)	12	15	18	26	33	35

3.9 Correction factors used in high altitude area

3.9.1 When the altitude is < 2,000m, it has no significant effect on the product performance.

3.9.2 When the altitude is >2,000m, air cooling effect and decrease of rated impulse withstand voltage shall be considered. Therefore, the manufacturer shall negotiate with users for design or use.

3.9.3 The following table is the table of electrical performance correction factor of the circuit breaker at the altitude >2,000m.

Table 10

Altitude (m)	2000	3000	4000	5000
Working current correction factor	1In	0.94In	0.88In	0.85In
Insulation voltage (V)	1Ue	0.8Ue	0.7Ue	0.6Ue
Power frequency withstand voltage (V)	0.3Uimp	0.25Uimp	0.2Uimp	0.18Uimp

TGM1N Series Moulded Case Circuit Breaker

3.10 Ambient temperature correction factor

3.10.1 When it is used at the normal working ambient temperature(-5°C-+30°C), it has no effect on product performance.

3.10.2 When working ambient temperature is >30°C- or < -5°C-, the tripping characteristics and temperature rise of the product will be affected by ambient temperature. Therefore, the manufacturer shall negotiate with users for design or use.

3.10.3 The following table is the table of correction factors of the circuit breaker at different ambient temperatures.

Table 11

Model	-35°C	-30°C	-25°C	-20°C	-15°C	-10°C	-5°C	0°C	30°C	35°C	40°C	45°C	50°C	55°C	60°C
TGM1N-63	1.4In	1.35In	1.3In	1.28In	1.25In	1.2In	1.15In	1.1In	1In	0.97In	0.95In	0.91In	0.9In	0.89In	0.85In
TGM1N-125	1.4In	1.35In	1.3In	1.2In	1.18In	1.15In	1.15In	1.1In	1In	0.95In	0.94In	0.93In	0.92In	0.91In	0.89In
TGM1N-160	1.4In	1.35In	1.3In	1.25In	1.22In	1.2In	1.15In	1.1In	1In	0.95In	0.94In	0.93In	0.92In	0.91In	0.89In
TGM1N-250	1.4In	1.35In	1.3In	1.25In	1.2In	1.18In	1.15In	1.1In	1In	0.95In	0.9In	0.89In	0.85In	0.81In	0.78In
TGM1N-320	1.4In	1.35In	1.3In	1.25In	1.2In	1.18In	1.15In	1.1In	1In	0.95In	0.9In	0.89In	0.85In	0.81In	0.78In
TGM1N-400	1.6In	1.55In	1.44In	1.42In	1.4In	1.35In	1.3In	1.25In	1In	0.95In	0.9In	0.89In	0.85In	0.81In	0.78In
TGM1N-630	1.35In	1.31In	1.3In	1.25In	1.2In	1.18In	1.13In	1.1In	1In	0.95In	0.94In	0.92In	0.9In	0.87In	0.86In
TGM1N-630 Large volume	1.42In	1.4In	1.35In	1.31In	1.3In	1.25In	1.2In	1.18In	1.13In	1.1In	1In	0.95In	0.94In	0.92In	0.9In
TGM1N-800	1.34In	1.32In	1.3In	1.3In	1.25In	1.23In	1.18In	1.13In	1In	0.95In	0.93In	0.85In	0.82In	0.8In	0.78In
TGM1N-1250	1.35In	1.34In	1.3In	1.28In	1.25In	1.21In	1.2In	1.17In	1In	0.92In	0.9In	0.88In	0.87In	0.86In	0.85In

Remarks: The reference ambient temperature of TGM1N-630 (large volume) is +40°C , and that of others is +30°C .

4 Normal working conditions and installation conditions

4.1 Ambient temperature

4.1.1 Normal working temperature is -5°C- +30°C, working temperature limit is -40°C - +70°C.

4.1.2 Derate according to the sample requirements when the temperature is <-5°C or > +30°C (see Table 11 for details).

4.2 Installation category

4.2.1 It is category-III for the main circuit and category- II for remaining auxiliary circuits.

4.3 Pollution class: 3

4.4 Altitude: 2,000 m, derating according to the sample requirements when above 2,000 m (see Table 10 for details).

4.5 Atmospheric conditions

4.5.1 The relative humidity is not more than 50% when the ambient temperature is +40°C;

4.5.2 A higher relative humidity is allowed at the lower temperature.

For example, the relative humidity may be 90% at +20°C. Special measures shall be taken for condensation due to temperature changes.

4.6 Shock and vibration

4.6.1 Withstand mechanical vibration with the frequency of 2Hz-13.2Hz, displacement of ±1mm and mechanical vibration with the frequency of 13.2Hz-100Hz and accelerated velocity of ±0.7g.

TGM1N Series Moulded Case Circuit Breaker

5 Accessories

Moulded case circuit breakers are provided with complete internal and external accessories to meet the demands of different customers.

5.1 Code of internal accessories

Table 12

OF	1N	-	125	L	D	A2
Accessory Code	Code of adapted circuit breaker		Code of frame current	Installation position	Mode of leading wiring out	Voltage grade
OF: auxiliary contact	1N:TGM1N		63, 125, 160, 250, 320, 400, 630, 630 large volume 800, 1250	L: Left side R: Right side	Default: Direct wire lead-out D: Terminal block box	Default: None A1: AC220/230/240V A2: AC380/400/415V D1: DC24V D2: DC110V D3: DC220V
SD: alarm contact						
MN: undervoltage release						
MX: shunt release						

* Note: Internal accessories of TGM1N-63/125H/R type is same as that of TGM1N-160

5.1.1 Auxiliary contact OF



- It is connected to the auxiliary circuit of the circuit breaker, and is used to remotely indicate the ON/OFF/free tripping status of the circuit breaker.

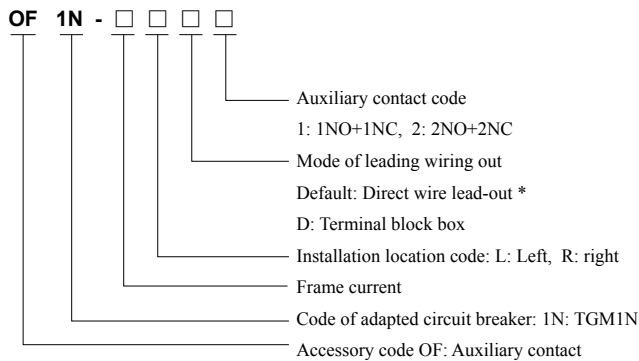

* Note: The length of direct wire lead-out is 50cm by default. For other lengths, please specify when ordering. For example, Code of the TGM1N-250 right auxiliary contact (with terminal box): OF1N-250RD2.

Wiring diagram

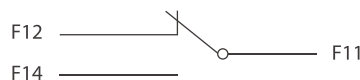

Status of the circuit breaker at “free tripping” and “opening” positions.



Status of the circuit breaker at “Closing” position.

Electrical characteristics

Frame rated current	Inm≤320A		400≤Inm≤800A		Inm > 800A	
Conventional heating current Ith	3A		6A		3A	
Use category	AC-15	DC-13	AC-15	DC-13	AC-15	DC-13
Rated working current	0.3A	0.15A	1A	0.15A	0.4A	0.15A

TGM1N Series Moulded Case Circuit Breaker

5.1.2 Undervoltage release MN

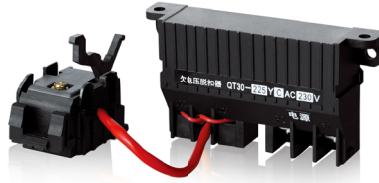

Achieve the undervoltage protection of the circuit breaker. It disconnects the circuit breaker when the power supply voltage is too low, to protect the electrical equipment.

a When the voltage is 35%-70% of the rated working voltage, the undervoltage release shall make the circuit breaker trip reliably.

b When the voltage is 85%-110% of the rated working voltage, the undervoltage release shall ensure the circuit breaker closed reliably.

c When the voltage is below 35% of the undervoltage tripper, the undervoltage release shall prevent the circuit breaker from closing.

* Note: The under-voltage release must be energized first in order to re-buckle and close the circuit breaker, otherwise it will damage the circuit breaker.

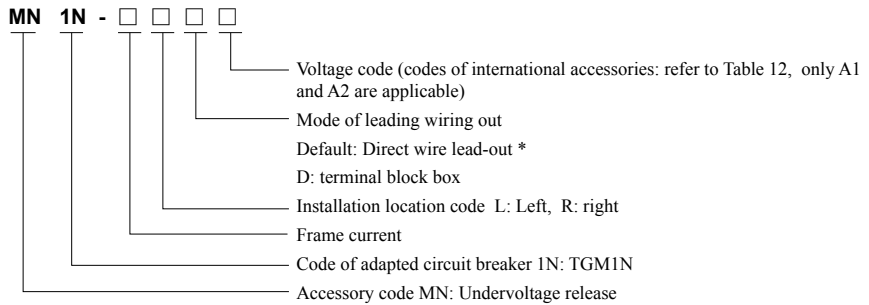

* Note: The length of direct wire lead-out is 50cm by default. For other lengths, please specify when ordering.

For example, Code of left undervoltage release AC220 (direct wire lead-out) of TGM1N-250: MN1N-250LA1.

• Wiring diagram

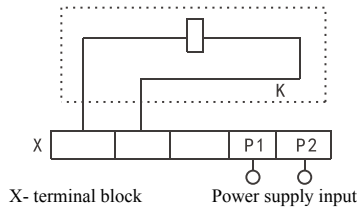

* Note: The internal wiring diagram of the circuit breaker is in the dashed box.

• Electrical characteristics

Model	Starting current value (mA)		Power consumption (W)	
	AC400V	AC230V	AC400V	AC230V
TGM1N-63/125 L/M	9.88	15.25	4.22	3.65
TGM1N-63/125 H/R TGM1N-160	9.95	15.55	4.55	3.82
TGM1N-250/320	10.88	15.83	4.85	3.92
TGM1N-400/630	9.5	11.2	3.8	2.83
TGM1N-800	5.4	7.75	2.7	1.85
TGM1N-1250	5.4	7.75	2.7	1.85

TGM1N Series Moulded Case Circuit Breaker

5.1.3 Alarm contact SD



- It is connected to the auxiliary circuit of the circuit breaker, and is used to indicate that the circuit breaker is at the ON/OFF or trip status.

Under the following four circumstances, the alarm contact will send a trip instruction:

- Overload or short-circuit failure
- Residual current failure
- Trip of test button
- Action of the shunt/undervoltage trip

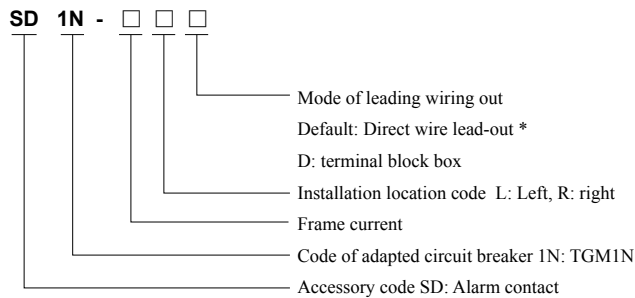

* Note: The length of direct wire lead-out is 50cm by default. For other lengths, please specify when ordering.
For example, Code of left alarm (direct wire lead-out) of TGM1N - 250: SD1N-250L.

• Wiring diagram



The circuit breaker is at free trip (alarm) status.

Status of the circuit breaker at "Opening" and "Closing" position.

• Electrical characteristics

Frame rated current	Inm<320A		Inm≥400A	
Conventional heating current Ith	3A		6A	
Use category	AC-15	DC-13	AC-15	DC-13
Rated working current	0.3A	0.15A	1A	0.15A

TGM1N Series Moulded Case Circuit Breaker

5.1.4 Shunt release MX

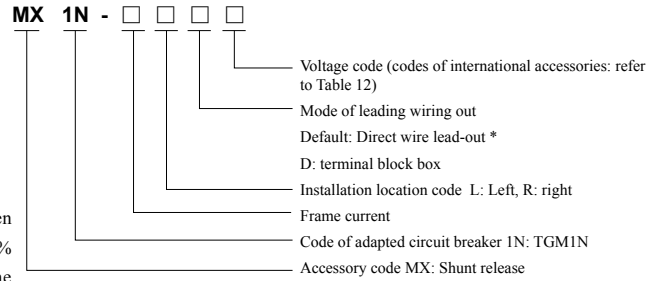

• It is used to achieve remote tripping. When the voltage of the circuit breaker is 70%-110% of the rated control supply voltage U_s , the shunt tripper shall make the circuit breaker trip reliably.

* Note: The length of direct wire lead-out is 50cm by default. For other lengths, please specify when ordering (the maximum length of the lead is 100mm).

For example, Code of left shunt DC220 (direct wire lead-out) of TGM1N-250: MX1N-250LD3.

• Wiring diagram

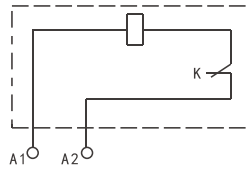

Power supply input

* Note:

K-The micro switch which cascade the shunt release and the coil. The switch is a NC contact; after opening of circuit breaker, the contact is automatically disconnected; the contact is closed when the circuit breaker switching on.

When the control voltage is DC24V, the maximum length of the copper lead shall meet the following requirements and the rated current at the wiring end of the tripper shall reach $5A \pm 0.5A$:

Rated control Power supply voltage U_c (DC24V)	Wire area	1.5mm ²	2.5mm ²
	100% power supply voltage		150m
85% power supply voltage		100m	160m

If the requirements in the above table are not met, the following figure is recommended for the design of the shunt tripper controller loop:

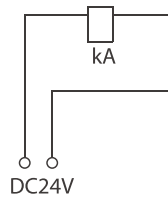

DC24V

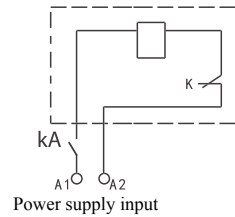

Power supply input

* Note: KA is DC24V intermediate relay, and the contact current capacity is 1A.

• Electrical characteristics

Model	Starting current value (mA)				Power consumption (W)			
	AC400V	AC230V	DC220V	DC24V	AC400V	AC230V	DC220V	DC24V
TGM1N-63/125 L/M	0.32	0.42	0.34	4.22	93.8	70	85.5	86.2
TGM1N-63/125 H/R TGM1N-160	0.35	0.45	0.37	4.52	95.8	73	90.7	91.2
TGM1N-250/320	0.42	0.48	0.39	4.51	112	68.8	90.7	85.3
TGM1N-400/630	0.48	0.51	0.41	4.51	132	78.3	94.4	110
TGM1N-800	0.54	0.85	1.21	5.51	163	153	158	120
TGM1N-1250	0.85	1.31	1.72	5.82	185	173	166	130

TGM1N Series Moulded Case Circuit Breaker

5.2 External accessory code

Table 13

CD2	IN	-	125	A2	
Accessory Code	Code of adapted circuit breaker		Code of frame current	Voltage grade	Code of pole number
AH: Circular hand-operated mechanism	1N:TGM1N		63, 125, 160, 250, 320, 400, 630, 630 large volume 800, 1250	A1: AC220/230/240V A2: AC380/400/415V D1: DC24V D2: DC110V DC3:DC220V	2 poles: 2P 3 poles: 3P 4 poles: 4P
RH: Square hand-operated mechanism					
CD2: AD/DC general electric motor operating mechanism					
GP: Front-panel connection transition plate					
GB: Phase partition					
BH: Rear-panel connection					
LS: Mechanical interlock					

* Note: Internal accessories of TGM1N-63/125H/R type is same as that of TGM1N-160

5.2 External accessories

5.2.1 Manual operated mechanism RN/AH



- The circuit breaker is operated by rotating the handle. The rotating handle that meets the ergonomics design makes the operation of circuit breaker more flexibly.

The manual operated mechanisms of TGM1N series circuit breakers can be divided into two types:

Extended rotating handle (circular and square extended hand-operated mechanism)

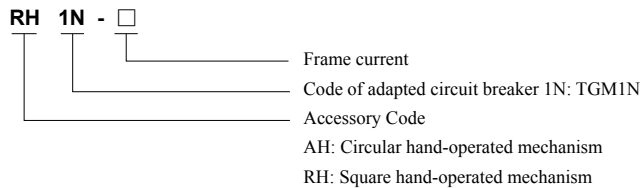

For example, Code of hand-operated mechanisms of TGM1N -250: AH1N-250.

- Outline dimension of hand-operated mechanism

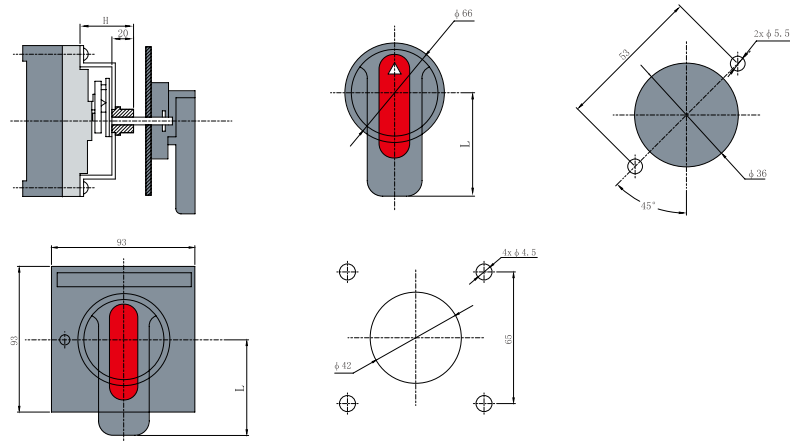

Model and specification	TGM1N-63/125 L/M	TGM1N-160 TGM1N-63/125 H/R	TGM1N-250/320	TGM1N-400/630	TGM1N-630 large volume	TGM1N-800
Installation dimension (H)	58	61	57	87	88	87
Handle length (L)	65	65	95	125	125	125

* Note: The length of the extended bar is 150mm by default and 500mm at maximum (Each 50mm is a specification)

TGM1N Series Moulded Case Circuit Breaker

5.2.2 Electric motor operating mechanism CD2



- Suitable for remote electric closing, opening and re-trip of the circuit breaker as well as automatic control situation.

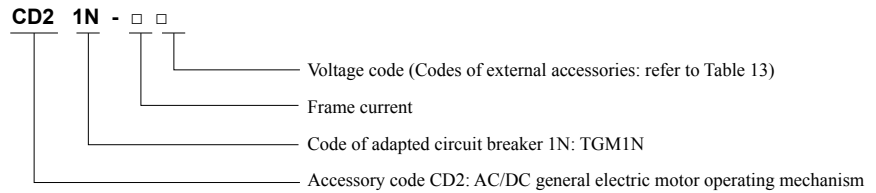

* For example: The code of the electric motor operating mechanism AC380V of TGM1N-250 is: CD21N-250A2.

- Electrical characteristics and wiring diagram

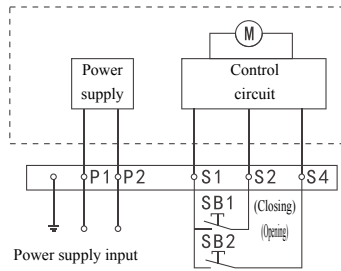

* Note:

K-The micro switch which cascade the shunt release and the coil. The switch is a NC contact; after opening of circuit breaker, the contact is automatically disconnected; the contact is closed when the circuit breaker switching on.

P1 and P2 are external power supply input

SB1 and SB2 are operating buttons (prepared by users)

- Outline and installation dimension

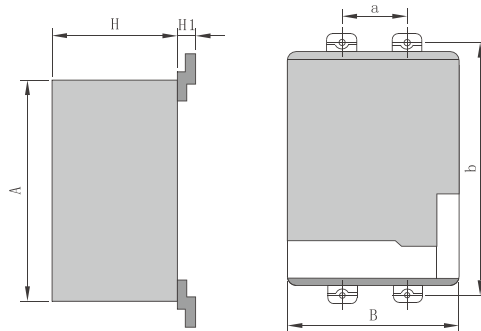

Model	A	B	H	H1	a	b
TGM1N-63/125 L/M	101	73	79	15	25	110
TGM1N-63/125 H/R TGM1N-160	116	90	79	20.5	30	129
TGM1N-250/320	116	90	79	16.5	35	126
TGM1N-400/630	174	130	117	35.5	44	194
TGM1N-630 large volume	174	130	117	28.5	58	200
TGM1N-800	174	130	117	33.5	70	243
TGM1N-1250	174	130	117	35.5	70	300

TGM1N Series Moulded Case Circuit Breaker

5.2.3 Front-panel wiring transition plate GP

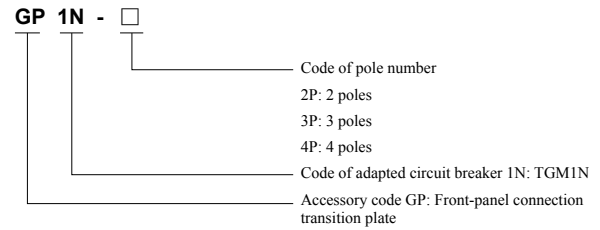
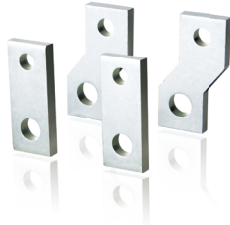

- It makes the wiring of the circuit breaker more flexible. The phase spacing and safety between circuits can be increased by installing this part.

Note: The code of extension terminal only covers the transition bar of the inlet line or the outlet line (for example, 3P circuit breaker only has 3 terminal boards). If the transition bar is required for inlet line and outlet line, 2 sets shall be ordered.

For example, Code of 3P transition plate of TGM1N-250: GP1N-2503P.

5.2.4 Phase partition GB

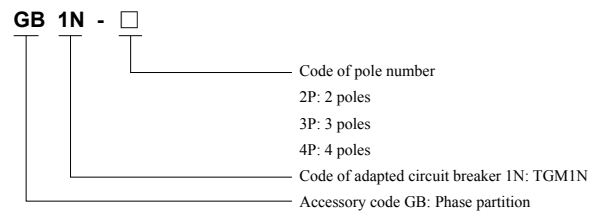

- The phase partition can enhance the insulation performance of conductors between phases and can be installed from the front slot even after the switch is installed.

* Note: Phase partition is the standard configuration for delivery. The number of phase partition is 2, 4, and 6 for a 2-pole, 3-pole and 4-pole circuit breaker, respectively. For example, Code of 3P phase partition of TGM1N -250: GB1N-2503P.

5.2.5 Rear-panel connection BH

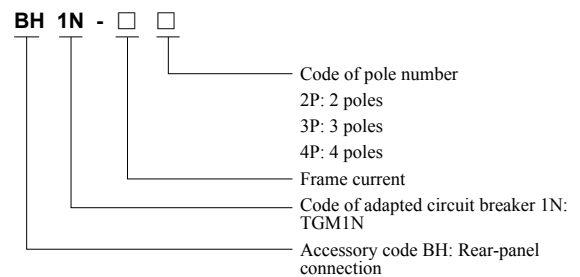

- It makes the wiring of the circuit breaker more flexible. The rear-board wiring can be achieved with it.

For example, Code of 3P rear-board of TGM1N-250: BH1N-2503P.

TGM1N Series Moulded Case Circuit Breaker

5.2.6 Mechanical interlock LS

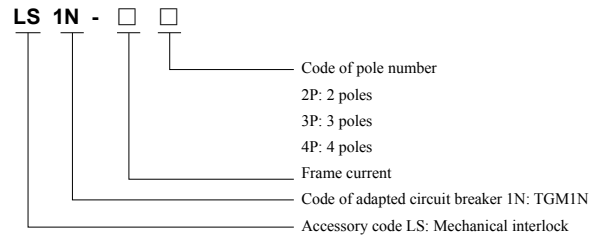

- Interlock two circuit breakers and prevent synchronous closing

For example, Code of 3P mechanical interlock of TGM1N-250: LS1N-2503P。

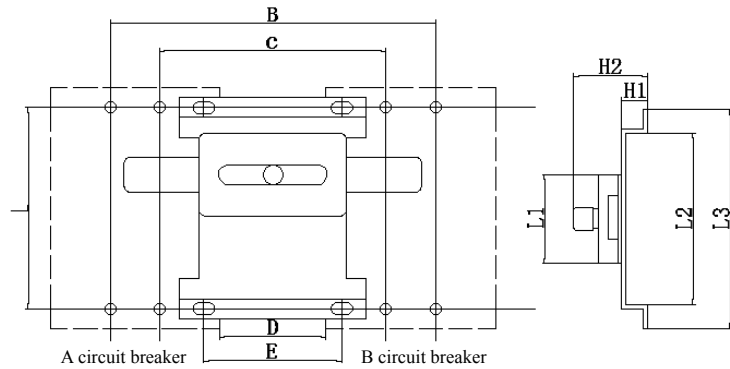

Outline and installation dimension diagram of TGM1N series 3P mechanical interlock

Model and specification	Outline and installation dimension (mm)								
	B	C	D	E	L1	L2	L3	H1	H2
TGM1N-63/125 L/M	130	80	30	80	40	82	106.5	20.5	45
TGM1N-63/125 H/R TGM1N-160	151	91	28.5	36	40	101	122	25	48
TGM1N-250/320	170	100	28	100	40	128	155	25	48
TGM1N-400/630	221.5	133.5	27.5	41	60	179	207	30.5	55
TGM1N-800	320	180	40	52	60	229	254	30.5	55

TGM1N Series Moulded Case Circuit Breaker

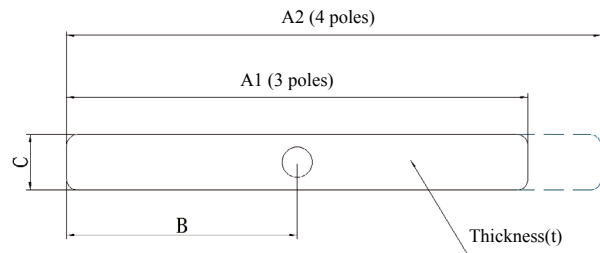

Model and specification	Outline dimension of slip strip (mm)				
	A1	A2	B	C	t
TGM1N-63/125 L/M	120	140	60	22	5
TGM1N-63/125 H/R TGM1N-160	120	152	60	22	5
TGM1N-250/320	130	166	65	22	5
TGM1N-400/630	190	235	96	28	6
TGM1N-800	250	323	125	28	6

6 Outline and installation dimension of the product

6.1 Outline and installation dimension of front-panel connection

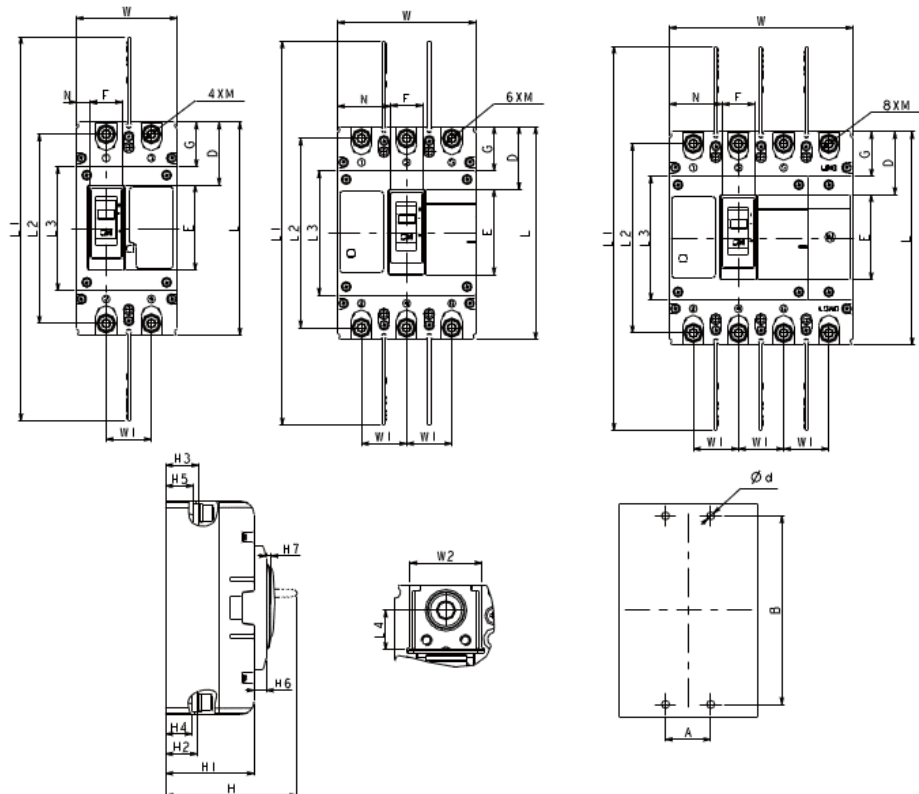

TGM1N Series Moulded Case Circuit Breaker

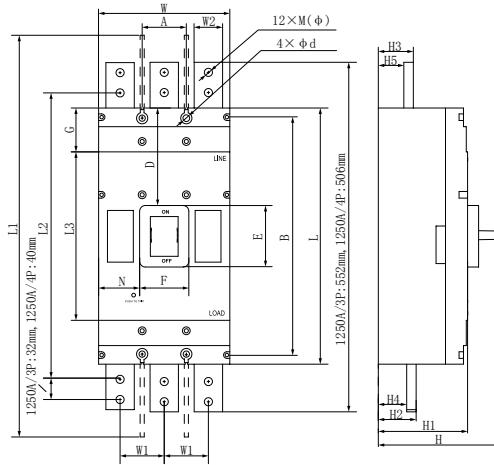

Outline and installation diagram of
TGM1N-1250

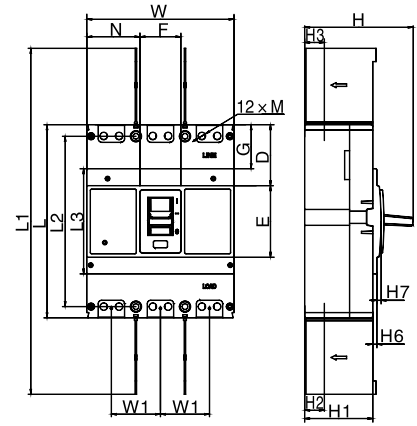

Outline and installation diagram of
TGM1N-1250 (small volume)

Table 14

Model	Breaking capacity	Pole number	Outline dimension (mm)												
			W	L	H	W1	W2	L1	L2	L3	L4	H1	H2	H3	
TGM1N-63/125	L/M	2P	50	130	86	25	16	230	115	75	7	58	27	27	
	L/M	3P	75	130	85	25	16	230	115	75	7	56	25	25	
	H/R		93	151	118	30	17.5	265	132.5	97	7.5	82	28.5	28.5	
	L/M	4P	100	130	85	25	16	230	115	75	7	56	25	25	
	H/R		123	151	118	30	17.5	265	132.5	97	7.5	82	28.5	28.5	
TGM1N-160	L	2P	62	151	100	30	17.5	265	132.5	97	7.5	64	25	25	
	M				118							82	28.5	28.5	
	L	3P	93	100	30	17.5	265	132.5	97	7.5	64	25	25		
	M/H/R			118							82	28.5	28.5		
	L	4P	123	100	30	17.5	265	132.5	97	7.5	64	25	25		
	M/H/R			118							82	28.5	28.5		
TGM1N-250/320	L	2P	78	165	103	35	25.5	300	147	96.5	14	69	24.5	25.5	
	M				118							85	22	22	
	L	3P	107	103	35	25.5	300	147	96.5	14	69	24.5	25.5		
	M/H/R			118							85	22	22		
	L	4P	142	103	35	25.5	300	147	96.5	14	69	24.5	25.5		
	M/H/R			118							85	22	22		
TGM1N-400	L/M/H	3P	150	257	154	48	32	468	223	156	13.5	102.5	38	38.5	
	L/M/H	4P	198												
TGM1N-630	L/M/H	3P	150	257	154	48	32	468	223	156	13.5	102.5	39.5	40.5	
	L/M/H	4P	198												
TGM1N-630 large volume	L/M/H	3P	182	270	158	58	40	478	234	155	15	105.5	41	43	
	L/M/H	4P	240												
TGM1N-800	L/M/H	3P	210	280	161	70	44	496	243	177	14	110	42	42	
	L/M/H	4P	280												
TGM1N-1250	/	3P	210	280	330	192	70	45	600	453	267	/	142	61	58
		4P	280									/			
TGM1N-1250 (small volume)	M/H	3P	210	275.5	155	70	45	470	243	150	16	97.5	37	28	
		4P	280												

TGM1N Series Moulded Case Circuit Breaker

Continued Table 14

Model	Breaking capacity	Pole number	Outline dimension (mm)										Installation dimension (mm)							
			H4	H5	H6	H7	E	F	D	G	N	M	A	B	Φd					
TGM1N-63/125	L/M	2P	24.5	24.5	10	4.5	44	18	43	27	3	M8	/	112	4					
	L/M	3P	22.5	22.5	10	4.5	44	18	43							28	M8	25	112	4
	H/R		25.5	25.5	12	5	69	21	41.5							35.5	M8	30	129	4.5
	L/M	4P	22.5	22.5	10	4.5	44	18	43							28	M8	25	112	4
	H/R		25.5	25.5	12	5	69	21	41.5							35.5	M8	30	129	4.5
TGM1N-160	L	2P	22	22	12	5	69	21	41.5	27	5	/	129	4.5						
	M		25.5	25.5																
	L	3P	22	22											35.5	M8	30			
	M/H/R		25.5	25.5																
	L	4P	22	22																
	M/H/R		25.5	25.5																
TGM1N-250/320	L	2P	20.5	21.5	9.5	4	66	24	49	34	11	/	125.4	4.5						
	M		18	18																
	L	3P	20.5	21.5											41	M8	35			
	M/H/R		18	18																
	L	4P	20.5	21.5																
	M/H/R		18	18																
TGM1N-400	L/M/H	3P	35.5	34.5	10.5	6.5	111	53	70	50	48	M10	44	194				7		
	L/M/H	4P											94							
TGM1N-630	L/M/H	3P	35.5	34.5	10.5	6.5	111	53	70	50	48	M10	44	194	7					
	L/M/H	4P											94							
TGM1N-630 large volume	L/M/H	3P	38.5	37	10	7	110	52	80	57	64	M12	58	200	7					
	L/M/H	4P																		
TGM1N-800	L/M/H	3P	37	36	9	6	105	49	83	51	80	M12	70	243	7					
	L/M/H	4P																		
TGM1N-1250	/	3P	46	43	/	/	98	78	155	70	65	φ13	70	375	11					
			41	26	/	/	100	78	110	/	65	φ13	70	299	9					
TGM1N-1250 (small volume)	M/H	3P	/	/	5.8	6	102.5	58.5	86.5	62.5	75.8	M10	70	243	8					
		4P																		

Remarks: The copper busbar thickness is 10mm for TGM1N-1250/800A, and 15mm for 1000A/1250A.

6.2 Installation dimensions of terminal board

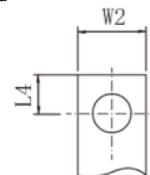

Copper bar

Installation dimensions of TGM1N terminal board (mm)

Table 15

Model	TGM1N-63/125	TGM1N-160	TGM1N-250/320	TGM1N-400	TGM1N-630	TGM1N-630 Large volume	TGM1N-800		
Breaking capacity	L/M	H/R	L/M/H/R	L/M/H/R	L/M/H	L/M/H	L/M/H		
Installation dimension	L4	7	7.5	7.5	10	12	12	15	13
	W2	16	16	16	20	28	30	40	40

TGM1N Series Moulded Case Circuit Breaker

7 Outline and installation dimension of plug-in type

7.1 Outline and installation dimensions of plug-in rear-panel connection

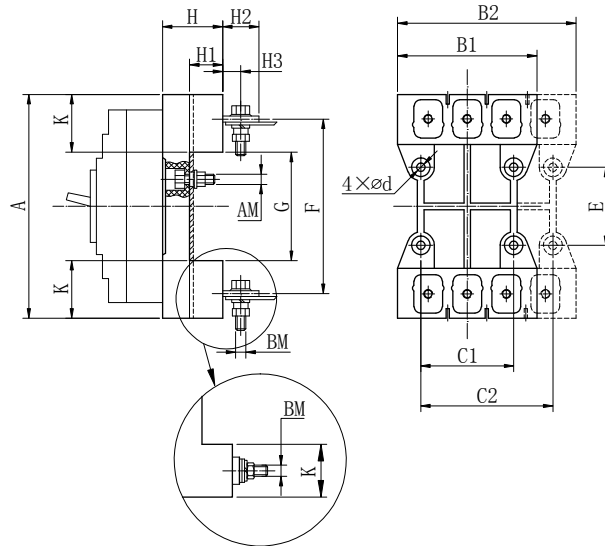

Note: Wiring mode of model 800 is shown as below in the figure

7.2 Hole size of the mounting plate (unit: mm)

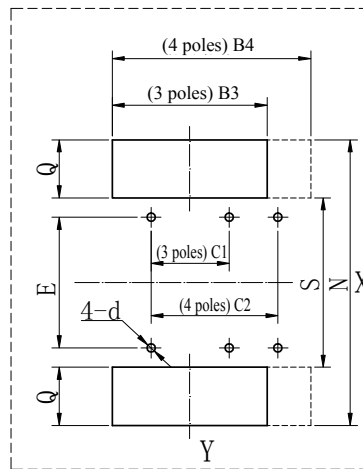
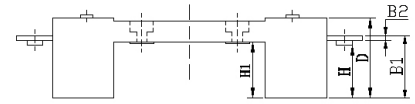
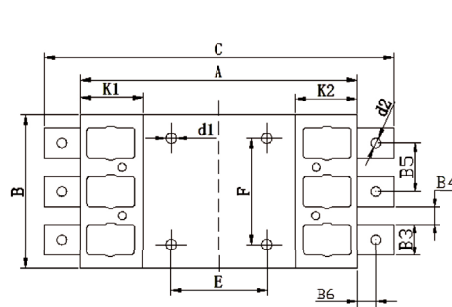

Table 16

Model	Outline and installation dimension (mm)																						
	A	B1	B2	C1	C2	E	F	G	K	H	H1	H2	H3	N	S	Q	B3	B4	AM	BM	4-d		
TGM1N-63/125 L/M	133	75	100	50	/	60	114	97	175	28	15	16	9	143	87	28	85	110	M5	M5	φ5.5		
TGM1N-63/125 H/R TGM1N-160	168	91	125	60	90	57	132	92	38	50	33	28	19	178	82	48	101	135	M6	M8	φ6.5		
TGM1N-250	186	107	145	70	105	54	145	94	46	50	33	37	20	196	84	56	117	155	M6	M8	φ6.5		
TGM1N-400 TGM1N-630	280	149	200	60	108	129	224	170	55	60	38	46	24	290	160	65	159	210	M8	M12	φ8.5		
TGM1N-630 large volume	300	182	242	100	158	123	234	170	65	60	39	50	/	310	160	75	192	252	M8	M12	φ8.5		
TGM1N-800	305	210	280	90	162	146	243	181	62	87	60	22	/	315	171	72	220	290	M10	M14(T)	φ11		

TGM1N Series Moulded Case Circuit Breaker

7.3 Outline and installation dimension of plug-in front-panel connection



TGM1N-63/125/250/320/630 large volume/800
Outline diagram of plug-in front-panel connection

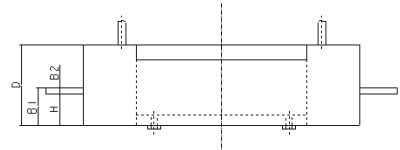

Outline diagram of plug-in front-panel connection of TGM1N-400/630

Table 17

Model	Outline and installation dimension (mm)																	
	A	B	C	D	E	F	H	H1	K1	K2	d1	d2	B1	B2	B3	B4	B5	B6
TGM1N-63/125 LM	136.5	75.5	188	48	55	50	23	30	22.5	22.5	ø4.5	ø6	25	2	12	13	25	17
TGM1N-63/125 H/R TGM1N-160	172	95.5	214	50	61	66	12.5	35	38	38	ø7	M8	18	3	19	10.5	30.5	10.5
TGM1N-250/320	183	110	259	52	64	70	42	35	44	44	ø7	M10	48	3	22	13	35	22.5
TGM1N-400/630	276	150	351	80	135	115	31	/	/	/	ø7	ø11	37	6	25	22.5	48	22
TGM1N-630 large volume	297	179	397	85	123	100	21	65	64	64	ø8.5	ø13	29	8	35	23	58	34
TGM1N-800	305	210	409	87	144	90	13	61	62	62	ø11	ø13	21	8	35	35	70	35

8 Ordering instructions

8.1 Please fill in relevant information in accordance with the product selection table when ordering.

For example, For ordering 200 sets of TGM1N circuit breakers, with frame current of 250A, breaking capacity of 35kA, 4 poles and B type, shunt AC200V and rated current of 200A, TGM1N-250M/4310B200AAC220V200 sets shall be filled in.

8.2 Product accessories can also be ordered separately and can be selected according to the selection table of internal/external accessories.

For example, For ordering 250 frames, with the accessory voltage of AC380V, and 100 sets of left undervoltage release, please fill in MN1N-250LA2100 sets.

TGM1N Series Moulded Case Circuit Breaker

9 Product selection table

9.1 Product selection table

TGM1N	250	M	Z	4	3	28	2	B	F	250A	AC220V	B	With terminal block box
Model	Frame current	Breaking capacity code	Operation mode code	Code of pole number	Tripping mode	Accessory Code	Usage code	N pole code	Additional information	Rated current	Voltage of accessories	Installation mode	Special requirements
TGM1N series moulded case circuit breaker	63/63A 125/125A	63A/125A L:25kA M:35kA H:50kA R:70kA	No code: Direct operation by hand	2: 2 poles	2: Single-magnetic type	00: no accessory 08: alarm contact 10: shunt release 20: auxiliary contact	Default: Power distribution protection	A: N pole is always on; N pole is not equipped with over-current tripping element.	T1: Transparent cover	10~1250A Refer to the comparison table of frame and rated current	AC220/230/240V AC380/400/415V	Default: Fixed, front-panel connection	Default: None
	160/160A 250/250A 320/320A	160A/250A 320A/L :35kA M:50kA H:70kA R:85kA	Z: operation of rotating handle	3: 3 poles	3: Thermal magnetic type	30: undervoltage release 40: shunt release+ auxiliary contact 50: auxiliary undervoltage release 60: two sets of auxiliary contacts	2: Motor protection	B: N pole is always on and is not equipped with over-current tripping element.	F: Prepayment		DC24V DC110V DC220V	B: Rear-panel connection	
	400/400A 630/630A 800/800A	400A/630A 800A: L:50kA M:70kA H:100kA	P: Electric motor operating mechanism	3N: 3-wire 4-pole		70: auxiliary contact+ undervoltage release 18: shunt release+ alarm contact 28: auxiliary contact+ undervoltage release+ alarm contact		C: N pole is always on, and is equipped with over-current tripping element.	III: Overload alarm without tripping			C: Plug-in rear-panel connection	
	1250: 1250A	1250A: L:80kA		4: 4 poles		68: two sets of auxiliary contacts+ alarm contact 78: undervoltage release+ auxiliary contact+ alarm contact		D: N pole is always on, and is equipped with over-current tripping element.					
						00: no accessory shall be selected for transparent cover circuit breaker							

TGM1N Series Moulded Case Circuit Breaker

9.2 Selection table of product internal accessories

OF	1N	125	L	D	A2
Accessory Code	Code of adapted circuit breaker	Code of frame current	Installation position	Mode of leading wiring out	Voltage grade
OF: Auxiliary contact	1N: TGM1N	63, 125, 160 250, 320	L: Left side	Default: Direct wire lead-out	Default: None A1:AC220/230/240V A2:AC380/400/415V
SD: Alarm contact		400, 630 800, 1250	R: Right side	D: Terminal block box	D1:DC24V D2:DC110V D3:DC220V
MN: Undervoltage release					
MX: Shunt release					

9.3 Selection table of product external accessories

CD2	1N	125	A2	Code of pole number
Accessory Code	Code of adapted circuit breaker	Code of frame current	Voltage grade	Code of pole number
AH: Circular hand-operated mechanism	1N: TGM1N	63, 125, 160 250, 320	A1:AC220/230/240V A2:AC380/400/415V	2 poles: 2P
RH: Square hand-operated mechanism		400, 630 800, 1250	D1:DC24V D2:DC110V D3:DC220V	3 poles: 3P
CD2: AC/DC general Electric motor operating mechanism				4 poles: 4P
GP: Front-panel connection transition plate				
GB: Phase partition				
BH: Rear-panel connection				
LS: Mechanical interlock				